

230 VOLT - 50Hz - 30VAmax.

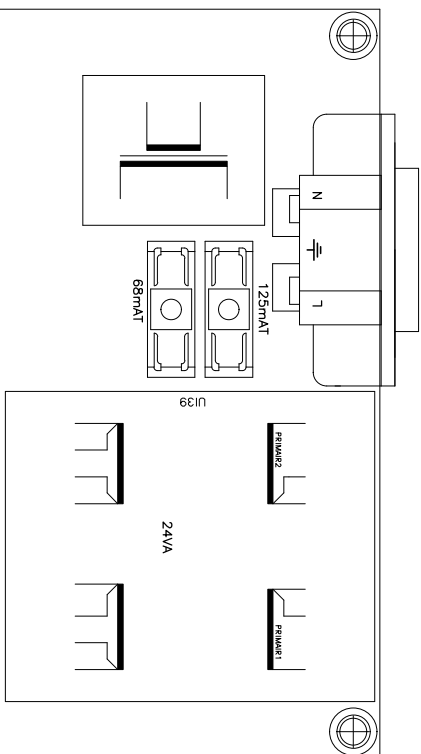

DOORLUSCONNECTOREN T.B.V.  
EXTERNE NACHTSCHOOT SIGNALERING

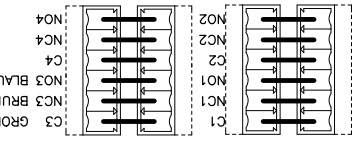

INDIEN SLOT NIET AANGESLOTEN  
DAN MS CONTACTEN DOORVERBINDEN

INDICATIE LED

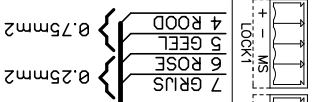
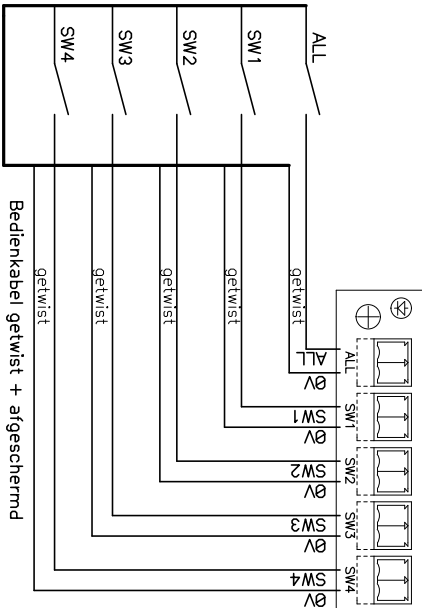

KABEL NAAR SLOT: 3x0.75 en 5x0.25 mm² / LENGTE MAXIMAAL 50 METER

SLOT 4150 MET PHOENIX CONNECTOR

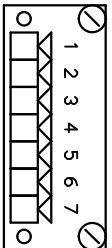

- Connector op slot
- 1 C CONTACT NACHTSCHOOT
  - 2 NC CONTACT NACHTSCHOOT (VERGRENDELD)
  - 3 NO CONTACT NACHTSCHOOT (ONTGRENDELD)
  - 4 SPOEL +
  - 5 SPOEL -
  - 6 C CONTACT SPOELSTAND
  - 7 NC CONTACT SPOELSTAND

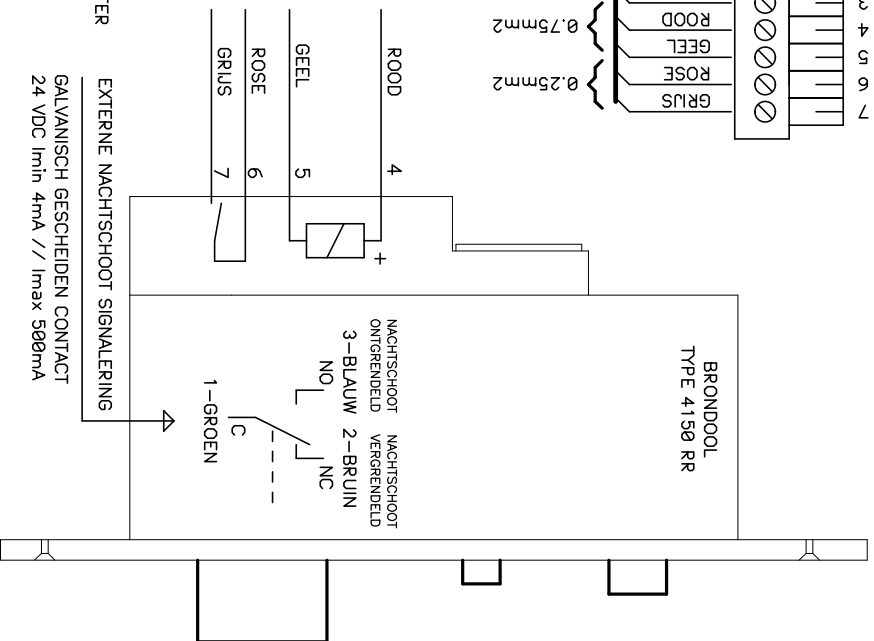
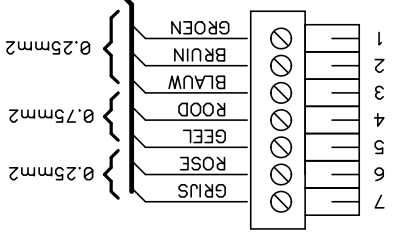

BRONDOOL elektrische deursloten

Aansluitschema 41-4 SLOT4150

.. \086731 \AANSLUIT\_P.PCB

Datum : 10-03-2005

ØV ADERS BIJ PANEEL DOORVERBINDEN